



US



EU



Product description

Elevate your presentation experience with the BalanceBox 400 manual height-adjustable wall mount. At the touch of a finger, this spring-operated mount easily adjusts 400mm/15.75" to ensure that the (interactive) display is positioned at the right working or viewing height. This non-powered system is the most intuitive and fastest height adjustable solution available on the market. Available in 3 versions, to cover any display of min.23kg - max.95 kg / min.50.7 – max.209 lbs. Convert it into a mobile solution with the optionally available "Mobile Stand Mix" for increased flexibility and mobility.

Article number	Product Description	Weight range*	
480A13	BalanceBox® 400 Light	23 – 43 kg	50.7 – 94.7 lb
480A12	BalanceBox® 400 Medium	41 – 69 kg	90.4 – 152 lb
480A14	BalanceBox® 400 Heavy	66 – 95 kg	145.5 – 209 lb

*REQUIRES THE "UNIVERSAL VESA MOUNT" (#481A70) TO MOUNT A DISPLAY TO THE BALANCEBOX 400
 *Calculate the combined weight of the panel, VESA bracket and any accessories to determine the required BalanceBox 400 model.

Material and finish:

- Frame: steel, powder coated, black textured (RAL9005)
- Front cover: thermoplastic ABS, black textured (RAL9005)
- VESA bracket: steel, powder coated, black textured (RAL9005)

Technical Specifications:

- Travel: 400 mm / 15.75 in

Compatibility:

- The BalanceBox 400 is compatible with flat screens up to 86" if the screen does not exceed the maximum weight-capacity of the BalanceBox 400

Certificates

- CE
- TÜV Baumuster geprüft (62368-1)
- UL/IEC/CSA (62368-1)



Accessories

Article number	Product description	Product weight	
481A41	3rd party VESA bracket interface	3,2 kg	7 lb
481A43001	Floor support II for BalanceBox® 400	12,9 kg	28.4 lb
481A54001	Conferencing camera and soundbar bracket	2,35 kg	5.2 lb
481A61001	Over-the-Whiteboard solution for BalanceBox 400	25 kg	59 lb
481A70	Universal VESA Bracket	5,2 kg	11.4 lb
481A71001	Mobile Stand Mix	38,5 kg	84.9 lb

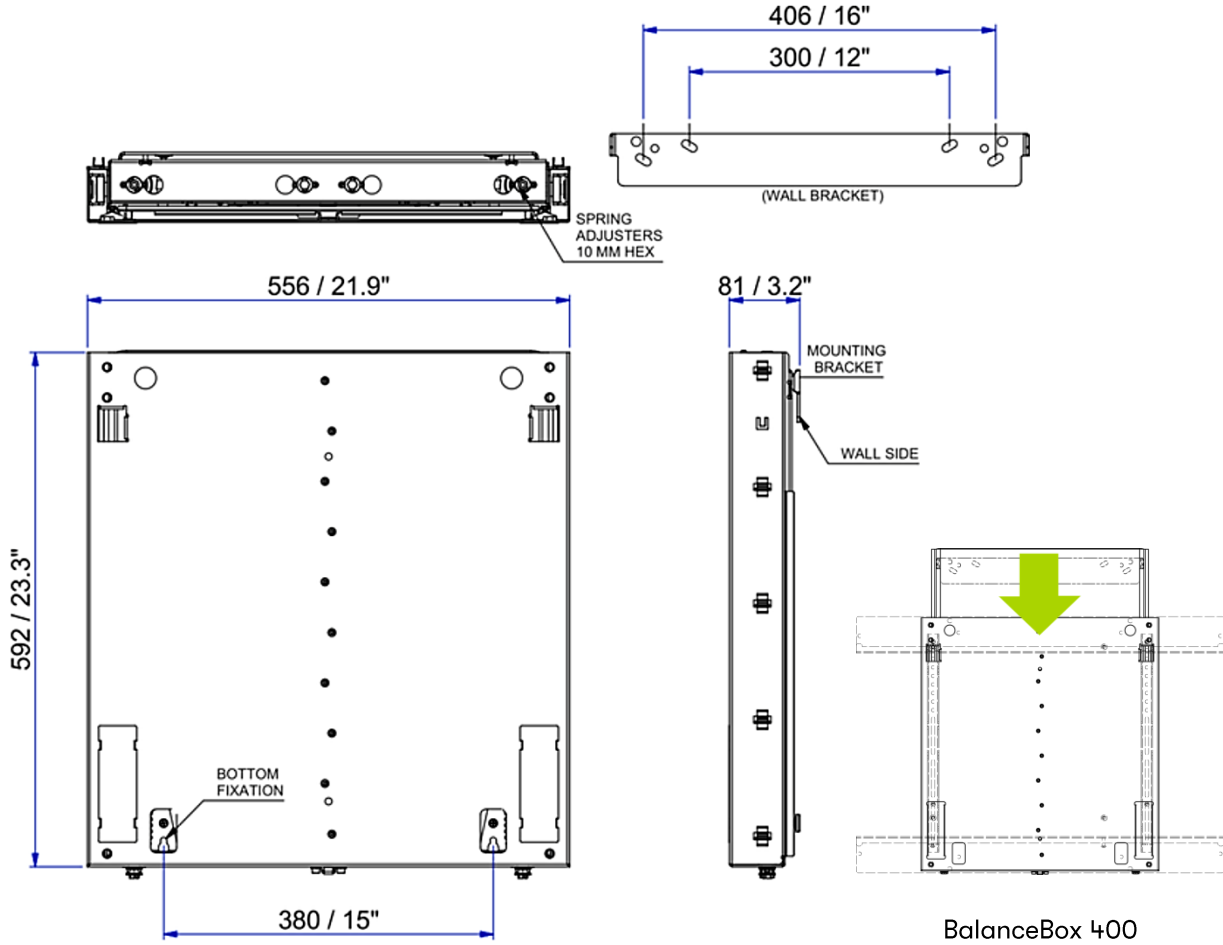

BalanceBox 400 moves down by 400 mm / 15.75"

Download technical drawings here



Dimensions

	Shipping dimensions		Pallet quantity: 12 each	
Length	670 mm	26.4 inch	720 mm	28.3 inch
Width	620 mm	24.4 inch	1160 mm	45.7 inch
Height	95 mm	3.75 inch	670 mm	26.4 inch
Shipping weight	± 23,9 kg	± 52.7 lb	± 287 kg	± 632 lb
Product weight	± 22,3 kg	± 49.1 lb		



Article number 481A71001

Mobile Stand Mix® for
BalanceBox® 400

US



EU

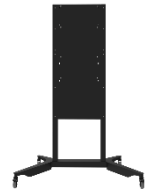

Product description

The Mobile Stand Mix is a heavy-duty mobile base designed for use with the Universal VESA bracket and the BalanceBox 400 adjustable wall mount. Create a simple yet heavy-duty fixed height display stand, by combining it with the Universal VESA bracket #481A70 or elevate the user experience by mounting the height adjustable BalanceBox 400 to create a mobile, height adjustable display stand. The recessed base reduces tripping hazard, while the 75mm/3" casters ensure smooth relocation of the stand.

Article number	Product Description	Load capacity	
481A71001	Mobile Stand Mix® for BalanceBox® 400	125kg	275.6 lb

Material and finish:

- Frame: steel, powder coated, black textured (RAL9005)

Product features:

- Compatible with panels up to 86" and max. 125 kg / 275.6 lb
- Two mounting positions for the BalanceBox 400, Universal VESA bracket ensure easy access to users of any stature.

Certifications

- CE
- TÜV Baumuster geprüft (62368-1)
- UL/IEC/CSA (62368-1)



Accessories

Article number	Product description
480A12 / 480A13 / 480A14	BalanceBox® 400
481A70	Universal VESA Bracket
481A73	Fixed Laptop Tray
481A81	Wheels Upgrade for Mobile Stands



US



EU

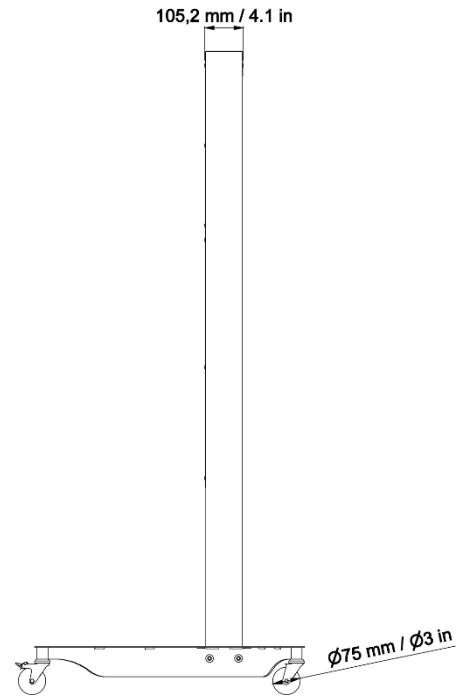
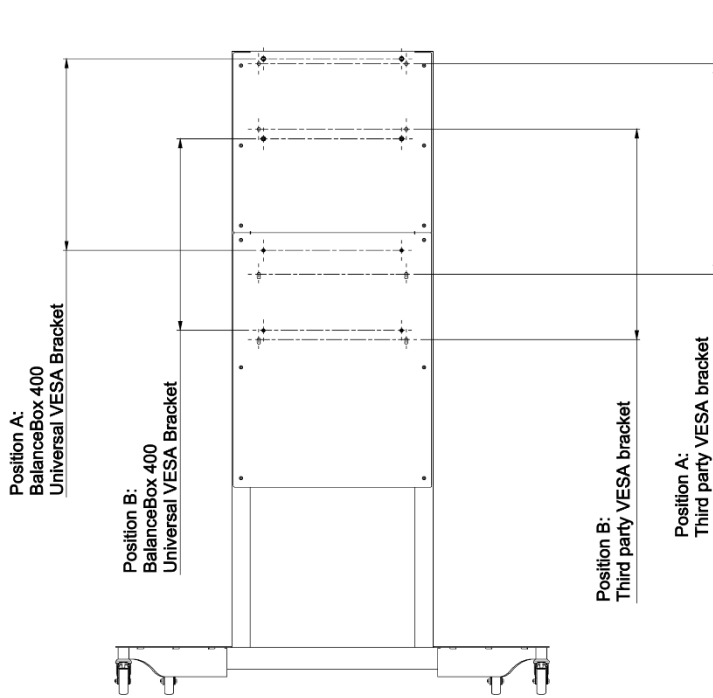
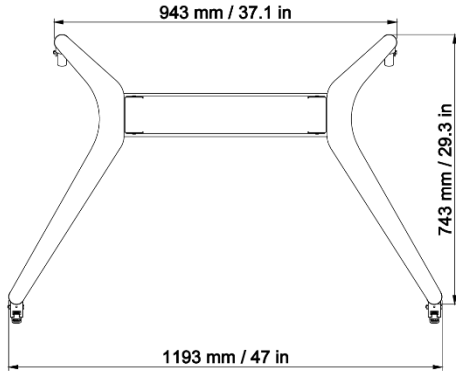
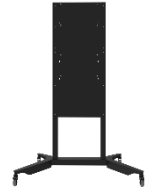

Download technical drawings here



EU



US

Dimensions

Shipping dimensions		
Length	1780 mm	70.1 inch
Width	650 mm	25.6 inch
Height	130 mm	5.2 inch
Shipping weight	±42 kg	±92.6 lb
Product weight	±38 kg	±83.8 lb
Pallet quantity	12 each	



US



EU



Product description

The Universal VESA Bracket is designed for mounting flat panel displays on BalanceBox products, with a load capacity of up to 220 kg. It is compatible with touchscreens featuring a VESA pattern from 200 x 200 mm to 800 x 600 mm.

Article number	Product Description	Load capacity	
481A70	Universal VESA Bracket	220 kg	485 lb

Material:

- Steel parts

Finish:

- Steel parts: Powder coated black RAL9005 textured

Certificates

- CE
- TÜV Baumuster geprüft (62368-1)
- UL/IEC/CSA (62368-1)



Compatible with

Article number	Product description
480A1x	BalanceBox® 400
484A1x	BalanceBox® 650
487A11xxx	e-Box®-II Mobile
487A12xxx	e-Box®-II Wall
481A71001	Mobile Stand Mix
481A43001	Floor Support II for BalanceBox® 400



US



EU

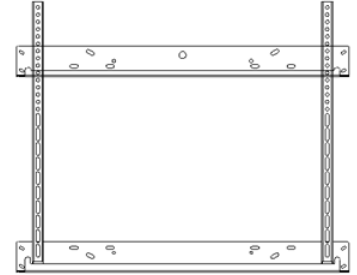
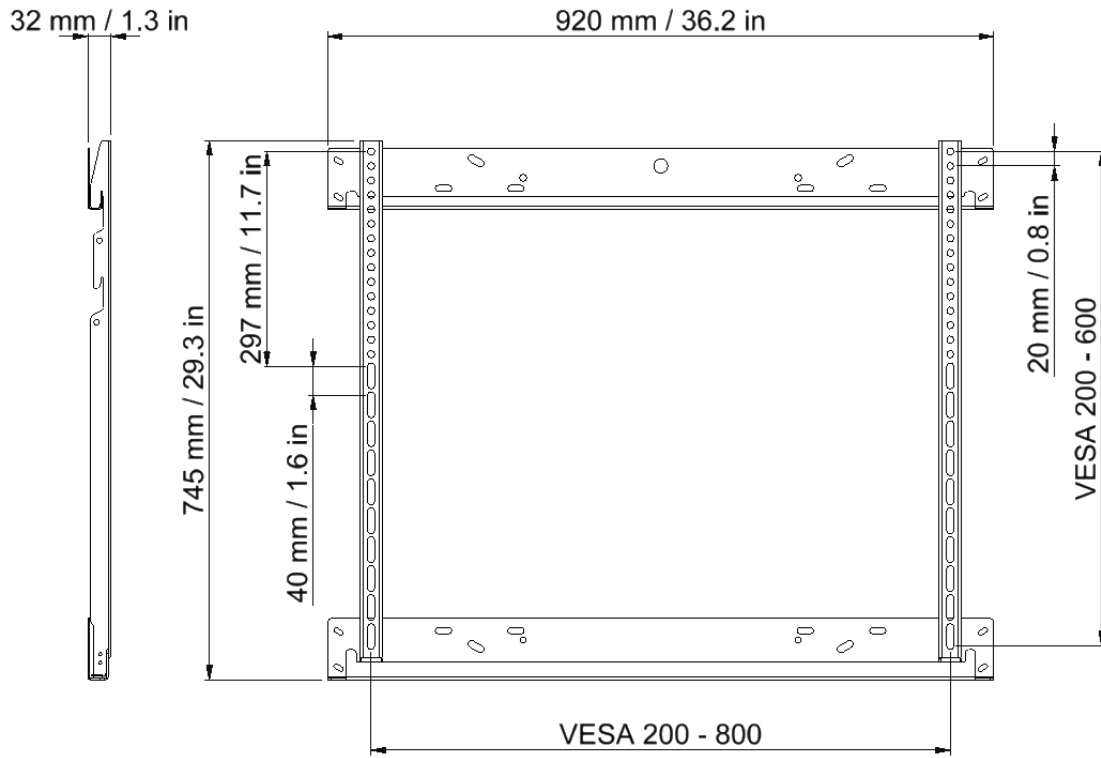
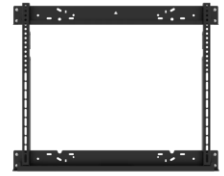

Configuration when mounted on BalanceBox 400 and Mobile Stand Mix

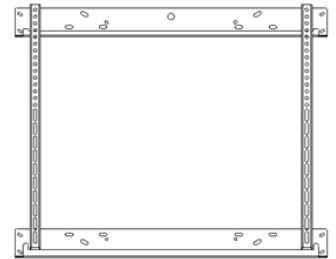

Configuration when mounted on BalanceBox 650 and Floor Support II for BalanceBox 400

Download technical drawings here



EU



US

Dimensions

Shipping dimensions		
Lenght	960 mm	37.8 inch
Width	105 mm	4.1 inch
Depth	43 mm	1.7 inch
Shipping weight	± 5,6 kg	± 12.3 lb
Product weight	± 5,2 kg	± 11.5 lb