



US



EU



Product description

The Whiteboard Lock for Winx 4b is an accessory that locks the closed whiteboards, protecting your interactive screen from unwanted use. All locks use the same key for easy access across the building when purchased in bulk.

Article number	Product Description
481A80	Whiteboard Lock for Winx® 4b

Material:

- Steel frame

Finish:

- Frame: Powder coated black RAL9005 textured
- Lock: Black RAL9005
- Key: Galvanised

Certifications

- CE



Compatible with

Article number	Product description
481A82 / 481A83	Winx® 4b
481A93	Winx® 4b Fixed Whiteboard Expansion Set

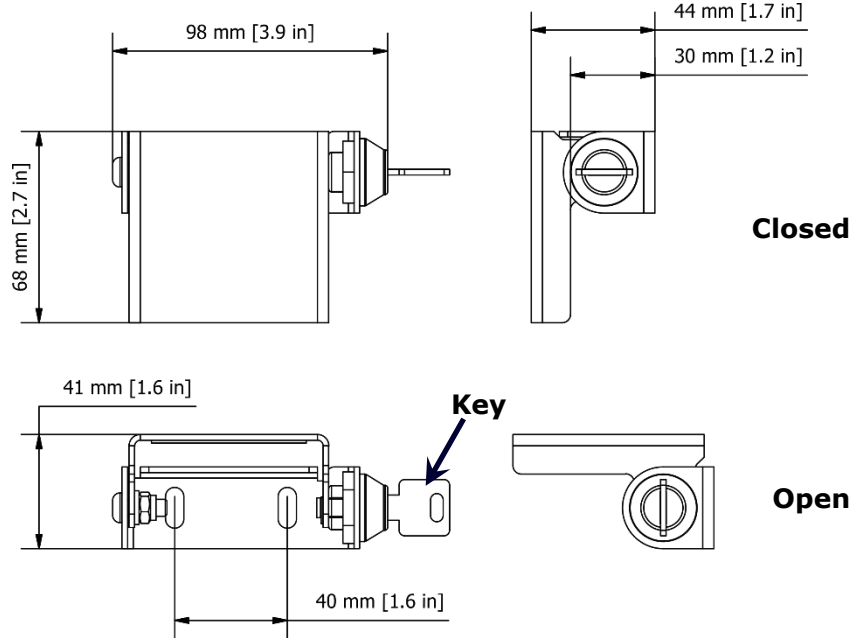

Dimensions

Shipping dimensions		
Height	138 mm	5.4 inch
Width	80 mm	3.1 inch
Depth	50 mm	2 inch
Shipping weight	±0,3 kg	±0.7 lb
Product weight	±0,2 kg	±0,4 lb

	Shipping Dimensions Bulk Box (50 pieces)		Shipping Dimensions Euro Pallet (600 pieces) *	
Height	411 mm	16.2 inch	414 mm	16.3 inch
Width	261 mm	10.3 inch	1194 mm	47 inch
Depth	297 mm	11.7 inch	789 mm	31 inch
Weight	±15 kg	±35 lb	±180 kg	±420 lb

* Dimensions excluding Euro Pallet (1200 mm x 800 mm | 47" x 31") | 600 pieces = 12 x Bulk Box